

INSTALLATION INSTRUCTIONS

4244

2002-2007 Jepp Liberty

Parts List :

QTY	(1) Hardware kit including :		
(1) Nerfstep set	(4) 1/2 x 1 1/2" Cut carriage head bolt	(8) 3/8 x 1 1/4" Hex. head bolt	
(2) Front mounting brackets	(2) 1/2 x 2" hex. head bolt	(8) 3/8" Flat washers	
(2) Rear mounting brackets	(2) 1/2 x 1 1/2" carriage head bolt	(8) 3/8" Lock washers	
(2) Auxiliary mounting brackets	(8) 1/2" Flat washer	(4) 3/8" Inserts	
	(8) 1/2" Lock washer	(1) Bolt guide	
	(6) 1/2" Hex Nut		

Tools Required :

9/16" Socket Ratchet
3/4" Socket

Instructions :

- 1.- Read and understand instructions completely before beginning installation.
 - 2.- Nerfstep set consist of a driver and passenger side. Be sure to determine the correct side before installation.
 - 3.- Place a 1/2 x 1 1/2" cut carriage head bolt through the slot and pull to the next hole. Attach (with a piece of tape) the bolt to the bolt guide to make easier the work, as shown in Picture 1. Place a 1/2 x 1 1/2" cut carriage head bolt in the slot, as shown in Picture 2.
 - 4.- Attach the front mounting bracket to the bolt placed in the hole using 1/2" flat washer and hex nut. Then attach the auxiliary mounting bracket to the bolt placed in the slot using 1/2" lock and flat washers and hex nut. Leave loose. Picture 3.
 - 5.- Locate existing slots in the vehicle frame as shown in Picture 4. Attach a 1/2 x 1 1/2" carriage hd. bolt to the bolt guide, then pull through the slots and rear mounting bracket as shown in Picture 5. Install two 3/8" inserts in existing holes in the rocker panel, as shown in Picture 6. Bolt rear mounting bracket to the inserts you installed using 3/8 x 1 1/4" hex hd. bolt lock and flat washers. Also secure rear mounting bracket to 1/2" bolt, using 1/2" flat washer and hex nut. Leave loose.
- Note:** Be sure to hold inserts when tightening screws until they are secure.
- 6.- Place the nerfstep up to the front mounting bracket secure into a place using 1/2 x 2" hex head bolt, lock and flat washers, as shown in Picture 7. Bolt to the rear mounting bracket using 3/8 x 1 1/4" hex head bolts, lock and flat washers. Leave loose.
 - 7.- Make any final adjustments to the alignment of the nerfstep on the vehicle and then tighten all of the fasteners. Repeat for the opposite side.
 - 8.- You may need to periodically re-tighten the fasteners on your nerfstep.

Assembly Diagram :

Picture 1

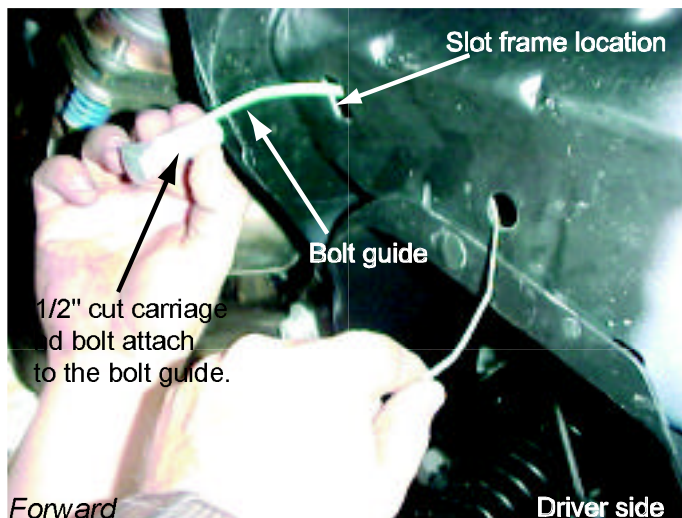

Picture 2

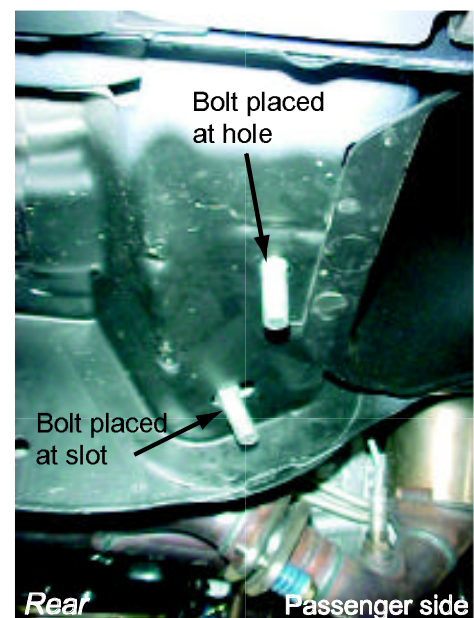

INSTALLATION INSTRUCTIONS

4244

Picture 3

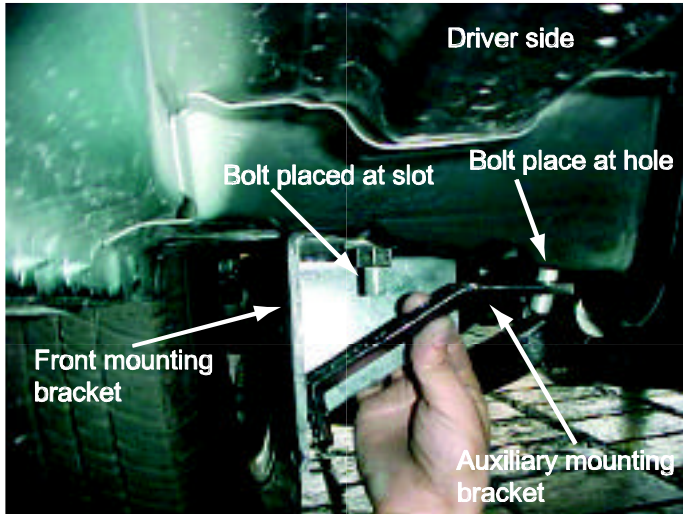

Forward

Picture 4

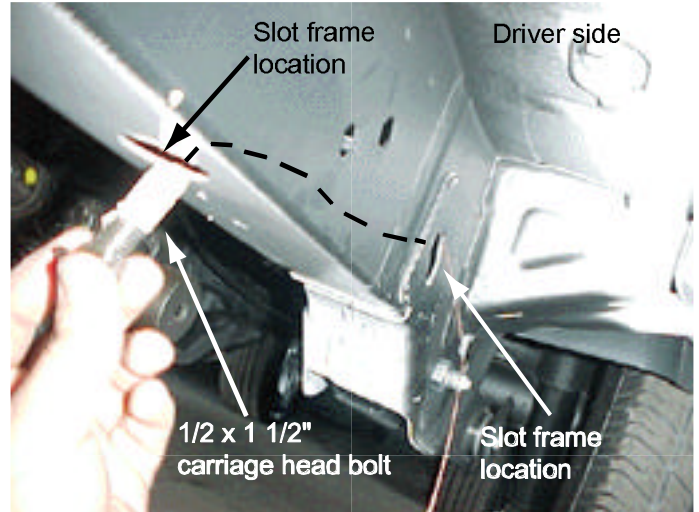

Rear

Picture 5

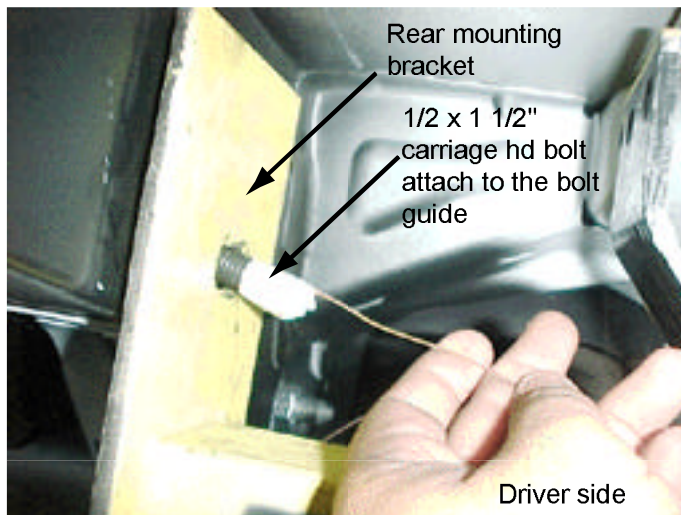

Rear

Picture 6

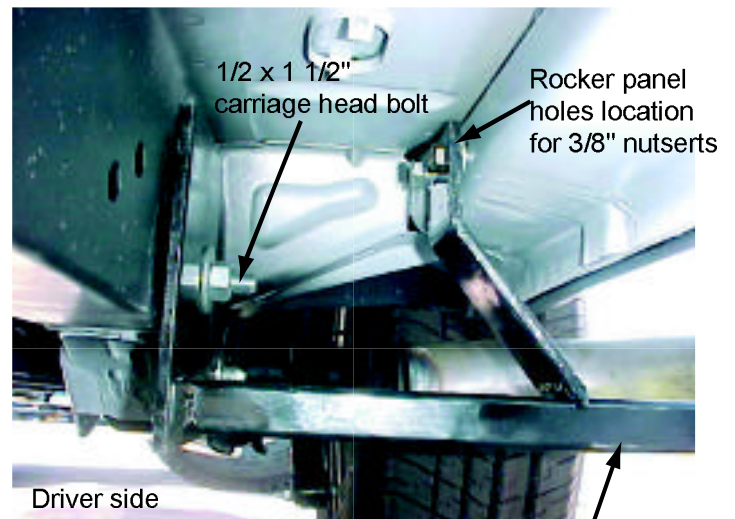

Rear

Rear mounting bracket installed

INSTALLATION INSTRUCTIONS

4244

Picture 7

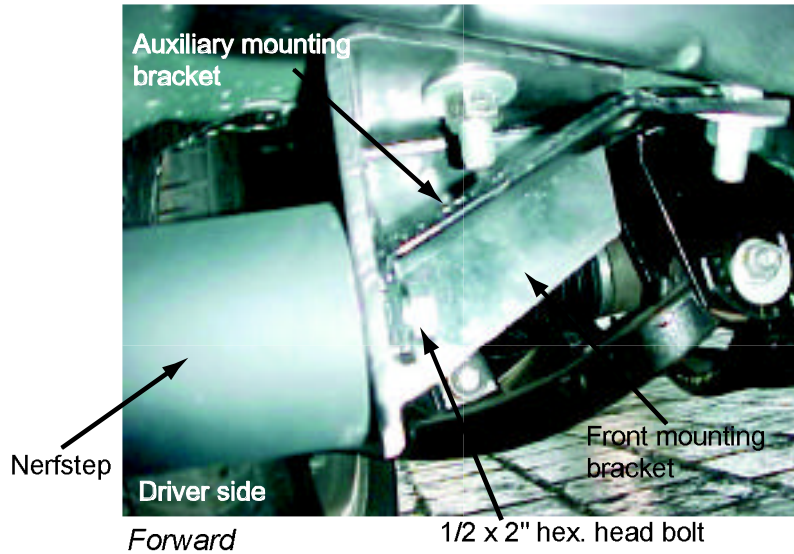

Cleaning and care instructions :

Protect the finish with a non-abrasive automotive wax, (e.g. Pure Carnauba) on a regular basis. The use of any soap, polish, or wax that contains an abrasive is detrimental to the finish, as the compounds scratch the finish and cause corrosion.